

240V Optical Alarm with 9V Battery Back-Up	1163
240V Heat Alarm with 9V Battery Back-Up	1165

## Description

Optical and Heat Alarms with replaceable 9V battery back-up. The alarms mount onto a wiring base.

Multiple optical and heat alarms can be interlinked together to provide detection and audible warning over larger areas or floors.

All products must be installed by a competent person in accordance BS 7671, the 17th Edition of the IET Wiring Regulations.

## Where to Locate

Smoke alarms need to be installed in circulation areas of a dwelling, for example, hall ways and landing, as a minimum, and ideally heat alarms need to be installed in kitchens, as required by BS 5839-6, Code of Practice for the design, installation, commissioning and maintenance of fire detection and fire alarm systems in domestic premises.

Ideally, alarms should be located:

- In living and sleeping areas.
- On each floor of the dwelling.
- In every room where electrical appliances are operated, e.g. portable heaters, tumble dryers.
- In each room where there are fossil fuel burning appliances, e.g. gas boilers, cookers, fire places.

It may be necessary to install more than one smoke alarm in an area, e.g. in halls/corridors that are more than 9m long. See diagram 1.

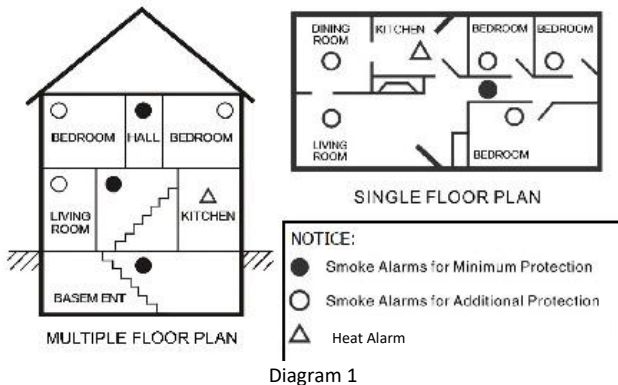

### Positioning of Alarms

- Smoke and heat from and burning materials rise to the ceiling and spread horizontally. Mounting the smoke alarm on the ceiling in the centre of the room places it closest to all points in the room. Ceiling mounting is preferred in ordinary residential dwellings.
- When mounting an alarm on the ceiling, locate it at a minimum of 500mm (20") from the side wall (See Diagram 2). If space restrictions prevent locating the alarm at 500mm (20") from the side wall, it can be located at absolute minimum of 300mm (12") from the side wall.

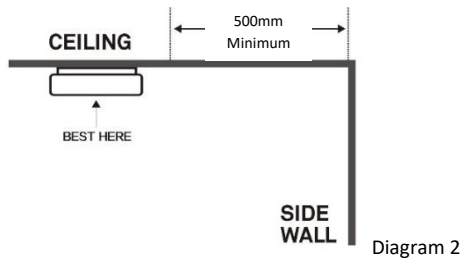

- Put smoke alarm at both ends of a hallway/corridor or large room if it is more than 9000mm (30') long.

- In rooms with an A shaped peaked ceiling, a sloped or cathedral ceiling, install a smoke/heat alarm between 500mm and 1500mm from the highest point of the ceiling. (See Diagram 3).

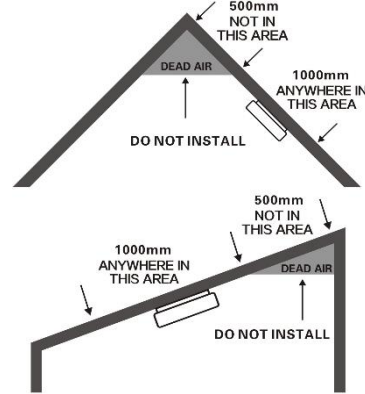

- Smoke alarms should not be installed within 900mm (3') of the following: the door to a kitchen, the door to a bathroom containing a tub or shower, forced air supply ducts used for heating or cooling, ceiling or whole house ventilating fans, or other high air flow areas.

### Do Not Install Smoke Alarms in the Following Places

- In unventilated garages as vehicle exhaust fumes may cause false alarming.
- In an area where the temperature may fall below 0°C or rise above 40°C, such as garages and unfinished attics.
- In dusty areas. Dust particles may cause nuisance alarm or failure to alarm.
- In very humid areas (greater than 93% R.H.), e.g. bathrooms. Moisture or steam can cause nuisance alarms.
- In insect-infested areas.
- Near fluorescent lights. Electronic "noise" may cause nuisance alarms.

### Important:

These alarms are primarily intended for use in single family occupancy private dwellings.

## Installation

This alarm should be installed as late as possible within the schedule of works, particularly in new build properties, e.g. after decorating and making good works.

- This alarm must not be connected to any other manufactures alarms.
- These alarms, item numbers, 1163 and 1165, are only compatible with each other; they are not compatible with previous generations.

### Important

The circuit powering the safety alarms must be unswitched, i.e. permanently live. The electrical supply for mains powered alarms with battery back-up, as required by BS 5839-6 Grade D systems, must:

- Be an independent circuit from the consumer unit where no other electrical equipment is connected, or
- A separately electrically protected, regularly used local lighting circuit

Also, where alarms are interlinked, they must be connected to a single circuit.

### Safety Instructions

- Ensure the power supply is switched off before installation and during maintenance.
- These alarms should be installed by a competent person, e.g. a qualified electrician.
- These alarms must be installed in accordance with the current edition of the IET Wiring Regulations BS7671 and the Code of Practice for the design, installation, commissioning and maintenance of fire detection and fire alarm systems in domestic premises BS 5839-6.
- **Important:** remove the alarm from the circuit for insulation resistance testing.

**If in doubt, contact a qualified electrician.**

### Installation

1. Remove the dust cover.
2. Release the alarm from the base by using a screw insert into the slots and flexing outwards, see diagram. 4

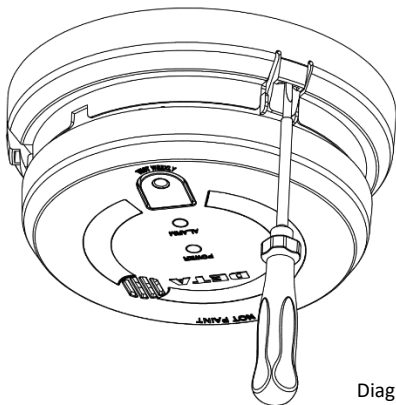

Diagram 4

3. Remove the electrical connector from the alarm by squeezing the locking arms.
4. Select the cable entry on the base and remove the cut out. Cable entry can either be through the back of the base or via surface mounted mini-trunking. Leave the gasket in place to prevent dust ingress into the alarm.
5. Mount the base in the desired location using the wall plugs and screws, as required. See Diagram 5.

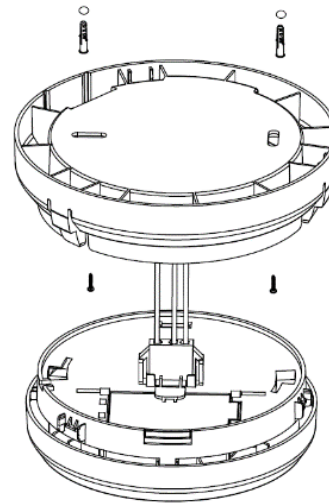
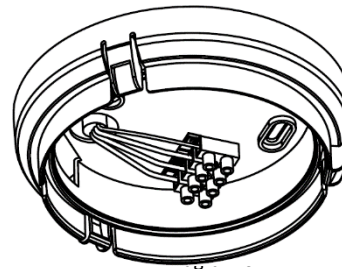

Diagram 5

6. Terminate the live, neutral and earth supply cables and interlink cable if alarms are interlinked. See Diagram 6.



L (Live):	Brown conductor
N (Neutral):	Blue conductor
E ⊕ (Earth):	Green / Yellow
I (Interlink):	Grey (if using 6243Y cable)

7. A maximum of 12 alarms can be interlinked. If more than 12 alarms are interlinked it may result in permanent damage.
8. For multiple alarm installations use three core and earth cable between all the alarms to be interlinked and connect the third core of that cable to terminal marked I. DO NOT use the earth wire for the interlink wire. This must be treated as live, i.e. insulated and sleeved.
9. Connect the battery by opening the battery cover and inserting it. Test the alarm by pressing the TEST button. See Diagram 7.
10. Refit the electrical connector.

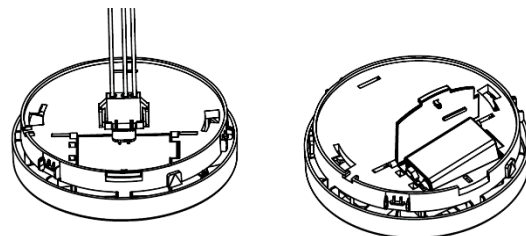

Diagram 7

11. Attached the alarm to the base
12. Replace the dust cap
13. Turning on the electrical power. The green LED should be lit when the alarm is operating from the power supply.
14. Test the alarm, including the interlink feature if more than one alarm is installed.

**Important:** Remove the alarm from the circuit for insulation resistance testing.

## User Information

Alarm Operation	What to do when the alarm sounds
<p><b>LED indicators</b></p> <p>Green LED: Connected to mains voltage power supply.</p> <p>Red LED: Flashing approximately every 32 seconds indicates that the smoke /heat alarm is operating properly.</p> <p>RED LED-Flashing: When the Test button is pressed, the smoke alarm senses smoke particles or the heat alarm senses an abnormal temperature, the alarm goes into alarm mode (constant pulsating sound) and the red LED will flash once per second. The flashing LED and pulsating sound will continue until the test button is released, the air is cleared from alarms sensors or the ambient temperature is normal.</p> <p>RED LED-Alarm silencer (Hush mode) indication: The red LED will flash every 8 seconds, indicating the alarm is in the silenced (hush) mode.</p> <p><b>Alarm silence (hush mode)</b></p> <ul style="list-style-type: none"> <li>Optical: Push TEST button to silence the alarm.</li> <li>Heat: Push SILENCE button for 2 seconds min. to activate.</li> <li>This silence feature is only to be used when a known alarm condition, such as smoke from cooking, activates the alarm. This feature is useful in areas such as kitchens to prevent nuisance alarms.</li> <li>The alarm will automatically reset itself after approx. 8 minutes. Should smoke particles still be present, the alarm will sound again.</li> </ul> <p><b>CAUTION:</b> Before using the alarm silence (hush), identify the source of the smoke and be certain a safe condition exists.</p> <p><b>DANGER:</b> If the alarm sounds, and it is not being tested, it means the unit is sensing smoke, <b>THE SOUND OF THE ALARM REQUIRES YOUR IMMEDIATE ATTENTION AND ACTION.</b></p>	<ol style="list-style-type: none"> <li>Alert small children in the home to quickly follow the family escape plan.</li> <li>Leave immediately by your escape plan. Every second counts, so don't waste time getting dressed or picking up valuables.</li> <li>In leaving, don't open any inside door without first feeling its surface. If hot, or if you see smoke seeping through cracks, don't open that door! Instead, use your alternate exit. Open the inside of the door is cool, place your shoulder against it, open it slightly and be ready to slam it shut if heat and smoke rush in.</li> <li>Stay close to the floor if the air is smoky. Breathe shallowly through a cloth, wet if possible.</li> <li>Once outside, go to your selected meeting place and make sure everyone is there.</li> <li>Call the fire department from your neighbour's home – not from yours!</li> <li>Don't return to your home until the fire officials say that it is all right to do so.</li> <li>If there is any question as to the cause of an alarm, it should be assumed that the alarm is due to an actual fire and the dwelling should be evacuated immediately.</li> </ol> <p><b>Note:</b> These guidelines will assist you in the event of a fire, however, to reduce the chance that fires will start, practice fire safety rules and prevent hazardous situations.</p> <p><b>Plan of Escape</b></p> <ul style="list-style-type: none"> <li>It is recommended that a plan of escape is developed and practiced. A floor plan indicating doors and windows should be made and, if possible, that two routes of escape are established.</li> <li>It is also recommended that fire extinguishers are installed and maintained.</li> </ul>

## User Maintenance

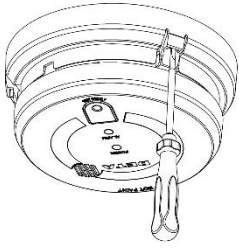
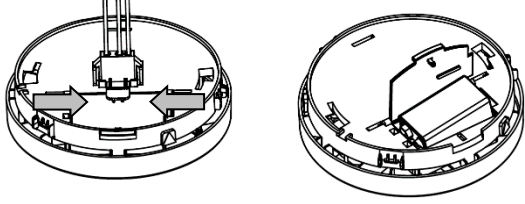
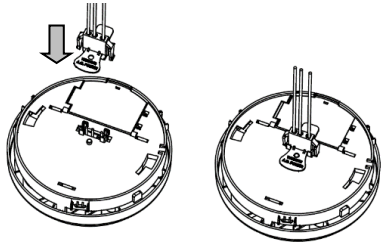
Replacing the Battery	
<p><b>Warning:</b> Only use the specified batteries (see Product Specification). Use of different batteries may have detrimental effect on the alarm. It is recommended that the battery is replaced when its voltage is low.</p> <ol style="list-style-type: none"> <li>Turn off the electrical supply to the alarms at the consumer unit/fuse box. The green power LED light will go off.</li> <li>To remove the alarm from the base, using a small flat blade screwdriver gently flex the locking clips on the side of the base away from the alarm. The alarm will then come away from the base. See Diagram 8.</li> </ol>  <p style="text-align: center;">Diagram 8</p> <ol style="list-style-type: none"> <li>To remove the electrical connector, squeeze the locking arms on the sides while pulling it away from the bottom of the alarm. See Diagram 9.</li> <li>After alarm has been removed, you can open the battery cover and replace with new battery. See Diagram 9.</li> </ol>  <p style="text-align: center;">Diagram 9</p> <ol style="list-style-type: none"> <li>After the battery is replaced, close the battery cover and test the alarm by pressing the TEST button.</li> <li>Reconnect the electrical connector, ensuring the orientation is correct and the locking arms snap back into place. See Diagram 10.</li> <li>Fit the alarm body on to the base, ensuring it clips securely into place.</li> </ol>	 <p style="text-align: center;">Diagram 10</p> <ol style="list-style-type: none"> <li>Turn on the electrical supply and the green LED light will come on. Test alarm by pressing the test button for at least 5 secs. The alarm will sound 3 short beeps – 1.5 seconds pause, and then repeat until the button is released.</li> </ol> <p>The smoke alarm will go into hush mode for approx. 8 minutes. During this period, the RED LED will flash once every 8 seconds. It will then go to normal status and flash once every 32 seconds. If there is no sound output when the test button is pushed, the alarm is may be defective faulty. See the section: "Trouble Shooting".</p> <p><b>Caution:</b> Test the alarm for correct operation using the test facility whenever the battery is replaced.</p> <p><b>Warning:</b> Electricity is dangerous. When replacing the battery, you must make sure the electrical AC power is turned off.</p>
<b>Battery</b>	
<ul style="list-style-type: none"> <li>It is recommended that the battery is replaced annually.</li> <li>This alarm uses a 9 volt battery. A new battery should last for at least one year under normal operate conditions.</li> <li>This alarm has a low battery monitor which will cause the alarm to "chirp" and at the same time as the red LED flash approx every 32 seconds for a minimum of thirty days when the battery gets low. Replace the battery when this condition occurs. Please refer to "Replacing the Battery".</li> </ul> <p><b>Important:</b> Do not attempt to remove the cover to clean inside. This will affect the warranty.</p>	

Testing the Alarm		Important Safety Information:	
<p>Test the alarm to ensure proper operation.</p> <ol style="list-style-type: none"> <li>Test alarm by pressing and holding the test button until it sounds. The alarm will sound 3 short beeps – 1.5 seconds pause, and then repeat until the button is released.</li> <li>If multiple alarms are installed within the dwelling, test each alarm. Each alarm should trigger other alarms connected within 10 seconds.</li> </ol> <p>Do not attempt to test the alarm with smoke or heat from a flame. Do <u>not</u> ignite combustible materials and start a fire.</p> <p>If no alarm sounds, the unit has a defective battery or other failure. Refer to “Trouble Shooting” section for a solution.</p> <p><b>Caution:</b> Due to the loudness (85 decibels) of the alarm, always stand an arms-length always from the unit when testing. Test the alarm weekly to ensure proper operation. Erratic or low sound coming from your alarm may indicate a defective alarm.</p> <p><b>NOTE: WEEKLY TESTING IS REQUIRED</b></p>		<ol style="list-style-type: none"> <li>This alarm must not be connected to any other manufactures alarms.</li> <li>These alarms, item numbers, 1163 and 1165, are only compatible with each other; they are not compatible with previous generations.</li> <li>Test alarm weekly to ensure proper operation. The test button accurately tests smoke alarm functions. Do not use any other test method.</li> <li>The alarm must not be exposed to dripping or splashing water.</li> <li>These alarms are primarily intended for use in single family occupancy private dwellings. In multifamily buildings, each individual living unit should have its own alarms. Do not install in non-residential buildings. This smoke alarm is not a substitute for a complete alarm system.</li> <li>The alarm may not alert every household member every time. The alarm horn is loud in order to alert individuals to a potential danger. However, there may be some circumstances where a household member may not hear the alarm (e.g. excessive outdoor or indoor noise, sound sleepers, drug or alcohol usage, the hard of hearing). If you suspect that this alarm may not alert a household member, install and maintain specialty alarms. Household member must hear the alarms warning sound and quickly respond to it to reduce the risk of damage, injury, or death that may result from fire. If a household member is hard of hearing, install special alarms with lights or vibrating devices to alert occupants.</li> <li>The alarms are designed to give audible warning of a developing fire and can only sound their alarms when they detect smoke, combustion particles in the air or abnormal ambient temperature. Many fires, however, are fast burning and in these circumstances the alarm may not be triggered quick enough to ensure a safe escape.</li> <li>The alarms have limitations. This alarm is not fool proof and is not warranted to protect lives or property from fire. The alarms are not a substitute for insurance. Occupants should insure their lives and property. In addition, it is possible for the alarm to fail at any time. For this reason, you must test the alarm weekly and replace unit after 10 years.</li> <li>Do not paint the alarms.</li> <li>Check the alarms on reoccupation of the premises after a vacation.</li> </ol>	
Maintenance			
<p><b>Cleaning</b></p> <p>The alarm should be cleaned on a monthly basis as a minimum. To do this:</p> <ul style="list-style-type: none"> <li>Turn off the electrical supply to the alarm.</li> <li>Use a vacuum cleaner with the soft brush to vacuum all sides and covers of alarm to remove dust, dirt, and debris. Be sure all the vents are free of debris.</li> <li>Use a damp cloth to clean the alarms cover.</li> <li>Turn the electrical supply to the alarm on.</li> </ul> <p><b>Battery</b></p> <p>The battery should be replaced annually. See ‘Replacing the Battery’.</p>			
Trouble Shooting			
Problem	Remedy	Problem	Remedy
The green LED does not light up	<ol style="list-style-type: none"> <li>Check electrical power supply is switched on</li> <li>Check the electrical connector is properly connected to the alarm</li> <li>If the problem still exists, replace the alarm</li> </ol>	The alarm chirp occurs every 32 seconds approx. and goes into fault mode	<ol style="list-style-type: none"> <li>Clean alarm. Refer to “Maintenance ”</li> <li>If the problem still exists, replace the alarm</li> </ol>
Alarm does not sound when tested. Note: push test button for at least five seconds while testing!	<ol style="list-style-type: none"> <li>Ensure that the battery and electrical connector is properly connected</li> <li>Clean alarm</li> <li>If the problem still exists, replace the alarm</li> </ol>	The alarm sounds intermittently or when residents are cooking, taking showers, etc. (false alarming)	<ol style="list-style-type: none"> <li>Press test button to pause alarm</li> <li>Open window or fan alarm to</li> <li>Clean alarm</li> </ol>
The alarm chirp occurs every 32 second approx. at the same time as the red LED flashes once	The battery needs replacing, refer to “Replacing the Battery”	The alarm sounds different from it is used to. It starts and stops.	<ol style="list-style-type: none"> <li>Clean alarm</li> <li>If the problem still exists, replace the alarm</li> </ol>
<b>Warning:</b> Do not disconnect battery to quiet an unwanted alarm. This will remove your protection. Fan the air or open a window to remove smoke or dust.			

Product Specification			
Voltage	220 – 240V @ 50Hz with 9V battery backup	Optical Alarm Button – dual function	<ul style="list-style-type: none"> <li>Push to Test</li> <li>Activate Silence (hush) mode</li> </ul>
Current	< 100mA	Silence (Hush) Time (approx.)	Smoke 8 minutes; heat 10 minutes
Battery Specification	9V battery DC. Brands: Gold Peak: GP1604S, GP1604A, or Raymax : 6LR61	Sound Pattern	ISO8201 (BI 0.5s - pause 0.5s - BI 0.5s - pause 0.5s - BI 0.5s - pause 1.5s, with the RED LED flash, then repeat)
Battery Life	Over one year		
Alarm Volume	> 85dB(A) at 3 meters	Inter-linkable	up to 12 detectors
Alarm Sensitivity	Optical: 0.114 - 0.160dB/m: Heat: 54°C to 70°C	Compliance	Optical: EN14604:2005/AC:2008 Heat: BS 5446-2:2003
Product Disposal	These alarms come under the Waste Electrical & Electronic Equipment Regulations and must be disposed of in accordance to these Regulations.		